

---

# TOYOTA STARLET CROSS



**OWN IT**



Issued on: 2025/10/14

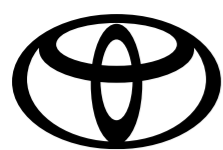

# SPECIFICATIONS

Starlet Cross 1.5L XR AT

Starlet Cross 1.5L XR MT

Starlet Cross 1.5L XS AT

Starlet Cross 1.5L XS MT

## Engine and Drivetrain

Bore x Stroke (mm)	74.0 x 85.0	74.0 x 85.0	74.0 x 85.0	74.0 x 85.0
Fuel System	Petrol	Petrol	Petrol	Petrol
Maximum Power (kW @ r/min)	77 @ 6000	77 @ 6000	77 @ 6000	77 @ 6000
Maximum Torque (Nm @ r/min)	138 @ 4400	138 @ 4400	138 @ 4400	138 @ 4400
Number of Cylinders and Arrangement	Inline-4	Inline-4	Inline-4	Inline-4
Engine capacity (litre)	1.5	1.5	1.5	1.5
Fuel Consumption (Combined Cycle) (l/100km)	5.8	5.6	5.8	5.6
CO2 Emission (g/km)	134	131	134	131

## Transmission

Transmission	Automatic-4-speed	Manual-5-speed	Automatic-4-speed	Manual-5-speed
Driven Wheels	FWD	FWD	FWD	FWD
Starting System	Push Start	Push Start	Rotary (Mechanical)	Rotary (Mechanical)

## Suspension

Front	MacPherson	MacPherson	MacPherson	MacPherson
Rear	Torsion-Beam	Torsion-Beam	Torsion-Beam	Torsion-Beam

## Wheels and Tyres

Spare Wheel	Full 195-60R16 steel	Full 195-60R16 steel	Full 195-60R16 steel	Full 195-60R16 steel
Tyre Size	F:195-60R16 alloy R:195-60R16 alloy	F:195-60R16 alloy R:195-60R16 alloy	F:195-60R16 alloy R:195-60R16 alloy	F:195-60R16 alloy R:195-60R16 alloy

## Body and Styling

Daytime Running Light	Standard LED	Standard LED	Standard LED	Standard LED
Door Outside Handles	Colour - Coded	Colour - Coded	Colour - Coded	Colour - Coded
Front Bumper	Colour Coded	Colour Coded	Colour Coded	Colour Coded
Headlights	LED	LED	LED	LED
Headlamp Levelling	Standard Manual	Standard Manual	Standard Manual	Standard Manual
High-Mounted Brake Light	Standard LED	Standard LED	Standard LED	Standard LED
Light Control System	Auto Light Control System, Follow me home	Auto Light Control System, Follow me home	Auto Light Control System, Follow me home	Auto Light Control System, Follow me home
Side Mirrors	Roof Colour Power / Auto-Retractable / With Indicator / Power Retractable	Roof Colour Power / Auto-Retractable / With Indicator / Power Retractable	Colour Coded Power / With Indicator / Power Retractable	Colour Coded Power / With Indicator / Power Retractable
Front Grille	Black, Chrome	Black, Chrome	Black, Chrome	Black, Chrome
Rear Bumper	Colour Coded Skid Plate	Colour Coded Skid Plate	Colour Coded Skid Plate	Colour Coded Skid Plate
Rear Lights	LED	LED	LED	LED
Side Protective Mouldings	Standard Black	Standard Black	Standard Black	Standard Black
Front Window Wiper	Intermittent, Time adjustable	Intermittent, Time adjustable	Intermittent	Intermittent
Rear Window Wiper	Intermittent	Intermittent	.	.
Rear Spoiler	Standard Roof Spoiler	Standard Roof Spoiler	Standard Roof Spoiler	Standard Roof Spoiler

## Interior, Comfort and Convenience

Door Inside Handles	Chrome	Chrome	Black	Black
---------------------	--------	--------	-------	-------

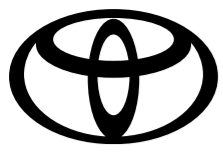

# SPECIFICATIONS

Starlet Cross 1.5L XR AT

Starlet Cross 1.5L XR MT

Starlet Cross 1.5L XS AT

Starlet Cross 1.5L XS MT

## Interior, Comfort and Convenience

Floor Carpet Trim	Carpet	Carpet		
Glove Box	Standard Light	Standard Light	•	•
Rear View Mirror	Electrochromatic (EC)	Electrochromatic (EC)	Day & Night	Day & Night
Key Reminder Warning	•	•	•	•
Luggage Room Lamp	•	•	•	•
2nd Row Seats	60:40 Manual	60:40 Manual	60:40 Manual	60:40 Manual
Room Lamp	•	•	•	•
Seat Trim	Fabric	Fabric	Fabric	Fabric
Shift Lever & Knob	Urethane, Chrome	Urethane, Chrome	Urethane, Chrome	Urethane, Chrome
Speedometer	Analog Tachometer	Analog Tachometer	Analog Tachometer	Analog Tachometer
Steering Wheel	3 Spoke Leather	3 Spoke Leather	3 Spoke Leather	3 Spoke Leather
Centre Console	Standard Cup holder	Standard Cup holder	Standard Cup holder	Standard Cup holder
Luggage Tray	•	•	•	•
Cruise Control	•	•	•	•
Airconditioner	Auto	Auto	Auto	Auto
Audio System	Toyota Display Audio, 9-inch	Toyota Display Audio, 9-inch	Toyota Display Audio, 7-inch	Toyota Display Audio, 7-inch
Reverse Camera	Display Audio Panoramic View Monitor	Display Audio Panoramic View Monitor	Display Audio	Display Audio
Bluetooth	•	•	•	•
Front Armrest	Standard With Slide	Standard With Slide	Standard With Slide	Standard With Slide
Front Seat Vertical Adjuster	Driver Manual	Driver Manual		
Light Remind Warning	•	•	•	•
Heads Up Display (HUD)	•	•		
Multi-Information Display	Standard TFT Colour, 4.2-inch	Standard TFT Colour, 4.2-inch	Standard Segment	Standard Segment
Power Socket	Front - 12V	Front - 12V	Front - 12V	Front - 12V
Power Steering	Electric / (EPS)	Electric / (EPS)	Electric / (EPS)	Electric / (EPS)
Electric Windows	All	All	All	All
Rear Airconditioner	Cooler Air Vents	Cooler Air Vents	Cooler Air Vents	Cooler Air Vents
Speakers	Standard 6	Standard 6	Standard 4	Standard 4
Steering Column Adjustments	Manual Tilt, Telescopic	Manual Tilt, Telescopic	Manual Tilt	Manual Tilt
Steering Switches	Standard Audio, Telephone, Cruise Control	Standard Audio, Telephone, Cruise Control	Standard Audio, Telephone, Cruise Control	Standard Audio, Telephone, Cruise Control
USB	Standard 3	Standard 3	Standard 3	Standard 3

Issued on: 2025/10/14

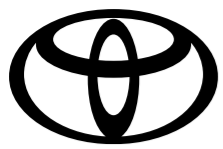

# SPECIFICATIONS

Starlet Cross 1.5L XR AT

Starlet Cross 1.5L XR MT

Starlet Cross 1.5L XS AT

Starlet Cross 1.5L XS MT

## Interior, Comfort and Convenience

Door Courtesy Lamp	•	•		
Wireless Charger	Standard Front x1	Standard Front x1		
Toyota Connect Enabled	•	•	•	•
Android Auto & Apple Carplay Connection	Standard Cable Android Auto, Wireless CarPlay	Standard Cable Android Auto, Wireless CarPlay	Standard Cable Android Auto, Wireless CarPlay	Standard Cable Android Auto, Wireless CarPlay
USB Type A	Standard 2PCs	Standard 2PCs	Standard 2PCs	Standard 2PCs
USB Type C	Standard 1PC	Standard 1PC	Standard 1PC	Standard 1PC

## Safety and Security

Anti-Theft System	Immobiliser Alarm	Immobiliser Alarm	Immobiliser Alarm	Immobiliser Alarm
Centre Rear Seatbelt	Standard 3-Point	Standard 3-Point	Standard 3-Point	Standard 3-Point
Child Lock	Standard Rear door	Standard Rear door	Standard Rear door	Standard Rear door
Child Restraint System (ISOFIX)	Standard 2	Standard 2	Standard 2	Standard 2
Front Brake	Ventilated Disc	Ventilated Disc	Ventilated Disc	Ventilated Disc
Front Seat Belts	ELR, Pretensioner, Force Limiter	ELR, Pretensioner, Force Limiter	ELR, Pretensioner, Force Limiter	ELR, Pretensioner, Force Limiter
Rear Brake	Drum	Drum	Drum	Drum
Rear Seat Belts	Standard ELR	Standard ELR	Standard ELR	Standard ELR
Seat Belt Warning	Front + Rear	Front + Rear	Front + Rear	Front + Rear
Wireless Door Lock	Standard Smart Entry	Standard Smart Entry	Standard Remote	Standard Remote
Rear Window Demister	•	•	•	•
Airbags	Side, Curtain, Driver, Passenger	Side, Curtain, Driver, Passenger	Side, Curtain, Driver, Passenger	Side, Curtain, Driver, Passenger

## Driver Support Systems

Park Distance Control	Standard Rear	Standard Rear	Standard Rear	Standard Rear
Anti-Lock Braking System (ABS)	•	•	•	•
Brake Assist (BA)	•	•	•	•
Electronic Brake Force Distribution (EBD)	•	•	•	•
Hill Assist Control (HAC)	•	•	•	•
Vehicle Stability Control (VSC)	•	•	•	•

## Service and Warranty

Service Plan	4 Services / 60,000km	4 Services / 60,000km	4 Services / 60,000km	4 Services / 60,000km
Service Interval	12 months / 15,000km	12 months / 15,000km	12 months / 15,000km	12 months / 15,000km
Warranty	3 years / 100,000km	3 years / 100,000km	3 years / 100,000km	3 years / 100,000km

## Dimensions and Capacities

Front Tread (mm)	1520	1520	1520	1520
Fuel Tank Size (L)	37	37	37	37
Gross Combination Mass (GCM)	2480	2480	2480	2480
Ground Clearance (mm)	170	170	170	170

Issued on: 2025/10/14

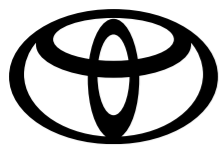

# SPECIFICATIONS

Starlet Cross 1.5L XR AT

Starlet Cross 1.5L XR MT

Starlet Cross 1.5L XS AT

Starlet Cross 1.5L XS MT

## Dimensions and Capacities

Gross Vehicle Mass (GVM)	1480	1480	1480	1480
Height (mm)	1550	1550	1550	1550
Kerb Weight (kg)	1010~1015	1005~1010	1010~1015	1005~1010
Length (mm)	3995	3995	3995	3995
Luggage Capacity (L)	304	304	304	304
Rear Tread (mm)	1530	1530	1530	1530
Towing Capacity - Unbraked (kg)	400	400	400	400
Towing Capacity - Braked (kg)	1000	1000	1000	1000
Turning circle (tyres, m)	4.8	4.8	4.8	4.8
Wheelbase (mm)	2520	2520	2520	2520
Width (mm)	1765	1765	1765	1765
Top Speed (km/h)	170	175	170	175

Issued on: 2025/10/14

**LINE DRAWING**

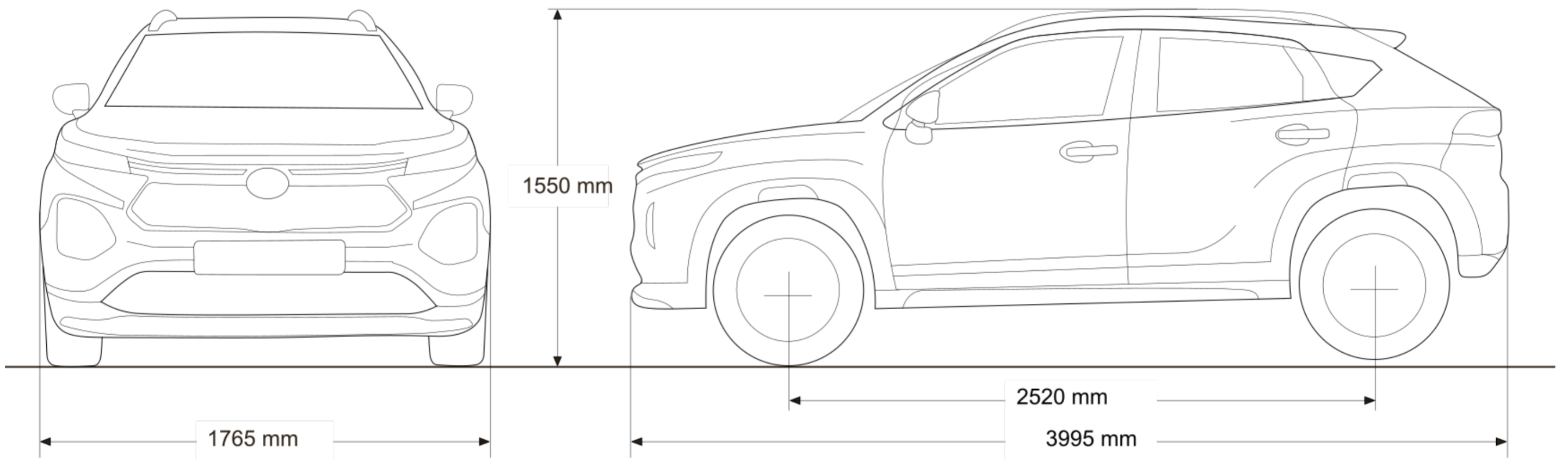

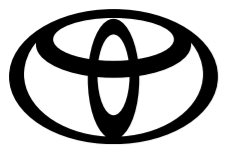

# SPECIFICATIONS

## EXTERIOR COLOURS

FOR ILLUSTRATIVE PURPOSES ONLY.

### MONOTONE



WB3 - Sonic Black Pearl



WBE - Premium Liquid Silver



WBF - Shadow Grey



WBH - Galaxy Blue



ZHJ - Mystic Pearl White



ZYE - Fine Orange

### BI-TONE

ONLY AVAILABLE ON XR MODELS.

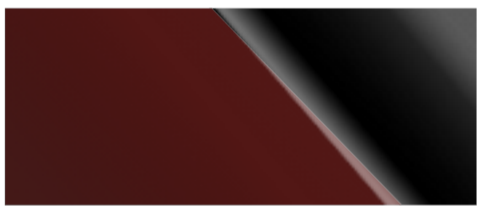

E86 - Luxe Red Bi-Tone

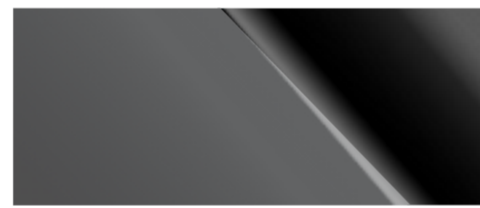

E85 - Liquid Silver Bi-Tone



E88 - Fine Orange Bi-Tone

# SPECIFICATIONS

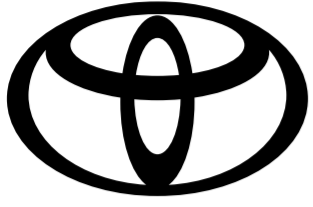

## **Disclaimer:**

The information contained within or made available on any Toyota platform or note including but not limited to, this website/brochure/specification sheet, is provided for information purposes only. While we make reasonable efforts to update the information on our platform/s, Toyota Motor Corporation of Japan, and Toyota South Africa Motors (Pty) Ltd makes no representations, warranties, or guarantees, whether express or implied, that the content is accurate, complete or up to date, and all information contained herein is subject to change without notice.

Vehicle specifications may vary depending on the model, trim level, and market. Colours depicted on print and web material may not match the actual vehicle colour. Fuel consumption figures are estimates based on standardised testing conditions and actual results may vary due to (but not limited to) driving style, vehicle loading, tyres, wind, traffic, and accessories. All dimensions, capacities, and performance figures are approximate. Some features/options may be optional or only available on certain models/trim levels. Images and illustrations are for illustrative purposes only and may not reflect the actual vehicle.

Your use of, or reliance on, any information or contents herein is entirely at your own risk. Toyota Motor Corporation of Japan and Toyota South Africa Motors (Pty) Ltd (including its owners, agents, consultants, employees, and any affiliated person(s)) are not responsible for any loss or damages related to your use of, reliance on, or understanding of any information or contents on this or any other Toyota platform. This includes, without limitation, any direct, indirect, special, incidental, consequential, or punitive damages in terms of any contract, delict (breach of a duty of care) or law.

Furthermore, Toyota Motor Corporation of Japan and Toyota South Africa Motors (Pty) Ltd do not guarantee the uninterrupted or error-free operation of any platform or the availability of content, and are not liable for any interruptions, errors, or damages caused by any technical issues or limitations of these platforms, including but not limited to, server downtime, software malfunctions, or internet connectivity issues.

