

TOYOTA URBAN CRUISER

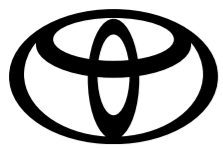

GO FIND YOUR FUN



Issued on: 2025/10/15



SPECIFICATIONS

Urban Cruiser 1.5 XR AT

Urban Cruiser 1.5 XR MT

Urban Cruiser 1.5 Xs MT

Engine and Drivetrain

| | | | |
|---|-------------|-------------|-------------|
| Bore x Stroke (mm) | 74 x 85 | 74 x 85 | 74 x 85 |
| Displacement (cm ³) | 1462 | 1462 | 1462 |
| Fuel System | Petrol | Petrol | Petrol |
| Maximum Power (kW @ r/min) | 77@ @ 6000 | 77@ @ 6000 | 77@ @ 6000 |
| Maximum Torque (Nm @ r/min) | 138@ @ 4400 | 138@ @ 4400 | 138@ @ 4400 |
| Number of Cylinders and Arrangement | Inline-4 | Inline-4 | Inline-4 |
| Engine capacity (litre) | 1.5 | 1.5 | 1.5 |
| Fuel Consumption (Combined Cycle) (l/100km) | 6.1 | 6.1 | 6.1 |
| CO2 Emission (g/km) | 144 | 146 | 146 |

Transmission

| | | | |
|-----------------|-------------------|----------------|----------------|
| Transmission | Automatic-4-speed | Manual-5-speed | Manual-5-speed |
| Driven Wheels | FWD | FWD | FWD |
| Starting System | Push Start | Push Start | Push Start |

Suspension

| | | | |
|------|--------------|--------------|--------------|
| Rear | Torsion-Beam | Torsion-Beam | Torsion-Beam |
|------|--------------|--------------|--------------|

Wheels and Tyres

| | | | |
|-------------|--|--|--|
| Spare Wheel | Full 215-60R17 Steel | Full 215-60R17 Steel | Full 215-60R17 Steel |
| Tyre Size | F:215-60R17 Alloy R:215-60R17 Alloy | F:215-60R17 Alloy R:215-60R17 Alloy | F:215-60R17 Alloy R:215-60R17 Alloy |

Body and Styling

| | | | |
|--------------------------|---|---|--|
| Antenna | Standard Shark Fin | Standard Shark Fin | Standard Shark Fin |
| Body Colour | Two tone & Monotone | Two tone & Monotone | Monotone |
| Daytime Running Light | Standard LED | Standard LED | Standard LED |
| Door Outside Handles | Colour - Coded | Colour - Coded | Colour - Coded |
| Front Bumper | Colour Coded | Colour Coded | Colour Coded |
| Headlights | LED | LED | Bi-Halogen |
| Headlamp Levelling | Standard Manual | Standard Manual | Standard Manual |
| High-Mounted Brake Light | Standard LED | Standard LED | Standard LED |
| Light Control System | Auto Light Control System, Follow me home | Auto Light Control System, Follow me home | |
| Side Mirrors | Roof Colour With Indicator / Power Retractable | Roof Colour With Indicator / Power Retractable | Colour Coded With Indicator / Power Retractable |
| Front Grille | Black, Chrome | Black, Chrome | Black, Chrome |
| Rear Bumper | Colour Coded | Colour Coded | Colour Coded |
| Rear Lights | LED | LED | LED |
| Front Window Wiper | Standard, Time adjustable | Standard, Time adjustable | Standard, Time adjustable |
| Rear Spoiler | Standard Roof Spoiler | Standard Roof Spoiler | Standard Roof Spoiler |
| Roof Rails | Standard Black | Standard Black | |

Issued on: 2025/10/15

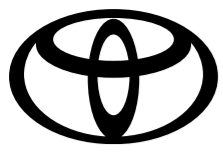

SPECIFICATIONS

Urban Cruiser 1.5 XR AT

Urban Cruiser 1.5 XR MT

Urban Cruiser 1.5 Xs MT

Interior, Comfort and Convenience

| | | | |
|------------------------------|-------------------------------|-------------------------------|-------------------------------|
| Assist Grip | Standard 3 | Standard 3 | Standard 3 |
| Coat Hook | Standard 1 | Standard 1 | Standard 1 |
| Cupholders | Standard 4 | Standard 4 | Standard 4 |
| Floor Carpet Trim | Carpet | Carpet | Carpet |
| Front Headrest | Adjustable 2 | Adjustable 2 | Adjustable 2 |
| Rear View Mirror | Day & Night | Day & Night | Day & Night |
| Meter Illumination Control | . | . | . |
| Rear Headrests | Adjustable 3 | Adjustable 3 | Adjustable 3 |
| 2nd Row Seats | 60:40 Manual | 60:40 Manual | 60:40 Manual |
| Seat Trim | Fabric | Fabric | Fabric |
| Shift Lever & Knob | Urethane | Urethane | Urethane |
| Speedometer | Analog Tachometer | Analog Tachometer | Analog Tachometer |
| Steering Wheel | 3 Spoke Leather | 3 Spoke Leather | 3 Spoke Leather |
| Seat Back Pockets | Standard Driver and Passenger | Standard Driver and Passenger | Standard Driver and Passenger |
| Centre Console | Standard Front | Standard Front | Standard Front |
| Luggage Tray | . | . | . |
| Cruise Control | . | . | . |
| Airconditioner | Auto | Auto | Auto |
| Audio System | Toyota Display Audio, 9-inch | Toyota Display Audio, 9-inch | Toyota Display Audio, 9-inch |
| Reverse Camera | Display Audio | Display Audio | Display Audio |
| Bluetooth | . | . | . |
| Door Ajar Warning | . | . | . |
| Footrest | . | . | . |
| Front Armrest | Standard With Slide | Standard With Slide | Standard With Slide |
| Front Seat Vertical Adjuster | Driver Manual | Driver Manual | Driver Manual |
| Light Remind Warning | Standard Buzzer | Standard Buzzer | Standard Buzzer |
| Heater | Manual | | |
| Multi-Information Display | Standard TFT Colour | Standard TFT Colour | Standard TFT Colour |
| Power Socket | Front - 12V | Front - 12V | Front - 12V |
| Power Steering | Electric / (EPS) | Electric / (EPS) | Electric / (EPS) |
| Electric Windows | All One Touch Driver only | All One Touch Driver only | All One Touch Driver only |

Issued on: 2025/10/15

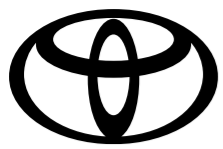

SPECIFICATIONS

Urban Cruiser 1.5 XR AT

Urban Cruiser 1.5 XR MT

Urban Cruiser 1.5 Xs MT

Interior, Comfort and Convenience

| | | | |
|------------------------------|---|---|---|
| Rear Airconditioner | Standard Air Vents | Standard Air Vents | Standard Air Vents |
| Rear Armrest | Standard 2 Cupholders | Standard 2 Cupholders | Standard 2 Cupholders |
| Speakers | Standard 4 | Standard 4 | Standard 2 |
| Steering Column Adjustments | Manual Tilt & Telescopic | Manual Tilt & Telescopic | Manual Tilt & Telescopic |
| Steering Switches | Standard Audio, Telephone, Cruise Control | Standard Audio, Telephone, Cruise Control | • |
| Sun Visor | Standard Mirror with Cover, Ticket Holder Driver + Passenger, Passenger Mirror with Cover | Standard Mirror with Cover, Ticket Holder Driver + Passenger, Passenger Mirror with Cover | Standard Mirror with Cover, Ticket Holder Driver + Passenger, Passenger Mirror with Cover |
| USB | Standard 3 | Standard 3 | Standard 3 |
| Rear Sunshade | • | • | • |
| Android Auto & Apple CarPlay | • | • | • |
| Toyota Connect Enabled | • | • | • |
| USB Type A | Standard 1PC | Standard 1PC | Standard 1PC |
| USB Type C | Standard 2PCs | Standard 2PCs | Standard 2PCs |

Safety and Security

| | | | |
|---------------------------------|----------------------------------|----------------------------------|-----------------------------|
| Anti-Theft System | Immobiliser Alarm | Immobiliser Alarm | Immobiliser Alarm |
| Centre Rear Seatbelt | Standard 3-Point | Standard 3-Point | Standard 3-Point |
| Child Lock | Standard Rear door | Standard Rear door | Standard Rear door |
| Child Restraint System (ISOFIX) | Standard 2 | Standard 2 | Standard 2 |
| Parking Brake | Lever | Lever | Lever |
| Front Brake | Ventilated Disc | Ventilated Disc | Ventilated Disc |
| Front Seat Belts | Pretensioner, Force Limiter | Pretensioner, Force Limiter | Pretensioner, Force Limiter |
| Power Door Lock | Standard | Standard | Standard |
| Rear Brake | Disc | Disc | Disc |
| Rear Seat Belts | Standard ELR | Standard ELR | Standard ELR |
| Seat Belt Warning | Front + Rear | Front + Rear | Front + Rear |
| Wireless Door Lock | Standard Smart Entry | Standard Smart Entry | Standard Smart Entry |
| Airbags | Side, Curtain, Driver, Passenger | Side, Curtain, Driver, Passenger | Driver, Passenger |

Driver Support Systems

| | | | |
|---|---------------|---------------|---------------|
| Park Distance Control | Standard Rear | Standard Rear | Standard Rear |
| Anti-Lock Braking System (ABS) | • | • | • |
| Electronic Brake Force Distribution (EBD) | • | • | • |
| Hill Assist Control (HAC) | • | • | • |
| Vehicle Stability Control (VSC) | • | • | • |

Service and Warranty

| | | | |
|--------------|-----------------------|-----------------------|-----------------------|
| Service Plan | 4 Services / 60,000km | 4 Services / 60,000km | 4 Services / 60,000km |
|--------------|-----------------------|-----------------------|-----------------------|

Issued on: 2025/10/15

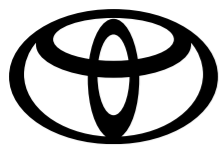

SPECIFICATIONS

Urban Cruiser 1.5 XR AT

Urban Cruiser 1.5 XR MT

Urban Cruiser 1.5 Xs MT

Service and Warranty

| | | | |
|------------------|----------------------|----------------------|----------------------|
| Service Interval | 12 months / 15,000km | 12 months / 15,000km | 12 months / 15,000km |
| Warranty | 3 years / 100,000km | 3 years / 100,000km | 3 years / 100,000km |

Dimensions and Capacities

| | | | |
|---------------------------------|-----------|-----------|-----------|
| Front Overhang (mm) | 915 | 915 | 915 |
| Front Tread (mm) | 1530 | 1530 | 1530 |
| Fuel Tank Size (L) | 45 | 45 | 45 |
| Gross Combination Mass (GCM) | 2820 | 2810 | 2810 |
| Ground Clearance (mm) | 210 | 210 | 210 |
| Gross Vehicle Mass (GVM) | 1620 | 1610 | 1610 |
| Height (mm) | 1645 | 1645 | 1645 |
| Kerb Weight (kg) | 1130-1165 | 1130-1165 | 1130-1165 |
| Length (mm) | 4365 | 4365 | 4365 |
| Luggage Capacity (L) | 373 | 373 | 373 |
| Rear Overhang (mm) | 830 | 830 | 830 |
| Rear Tread (mm) | 1535 | 1535 | 1535 |
| Towing Capacity - Unbraked (kg) | 400 | 400 | 400 |
| Towing Capacity - Braked (kg) | 1200 | 1200 | 1200 |
| Turning circle (tyres, m) | 5.4 | 5.4 | 5.4 |
| Wheelbase (mm) | 2600 | 2600 | 2600 |
| Width (mm) | 1795 | 1795 | 1795 |
| Top Speed (km/h) | 165 | 170 | 170 |

Issued on: 2025/10/15

LINE DRAWING

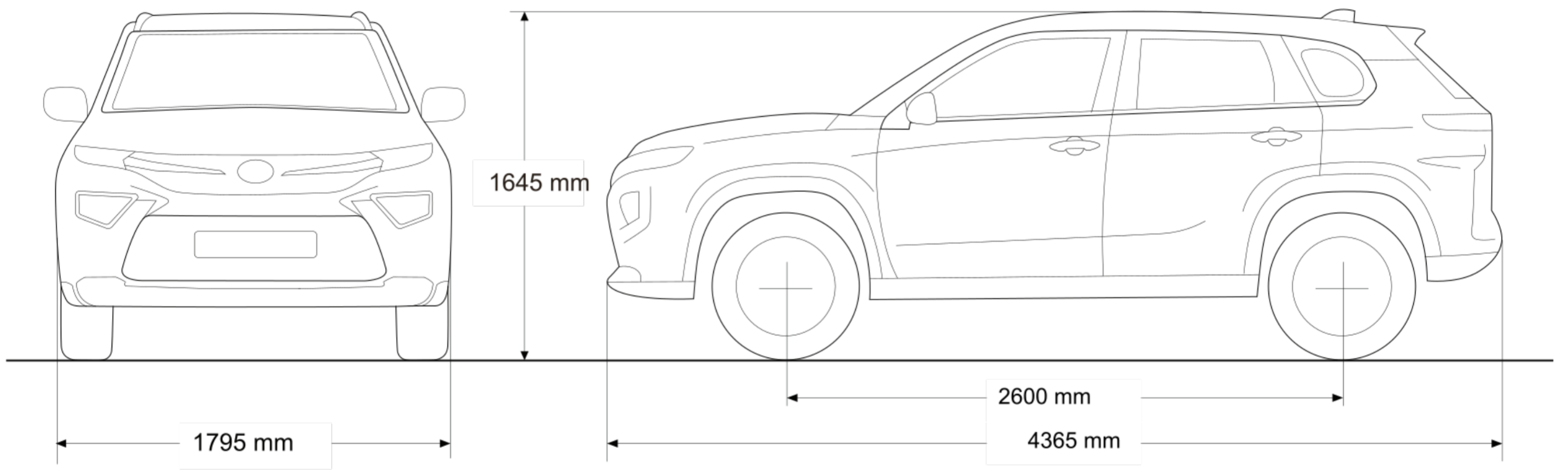

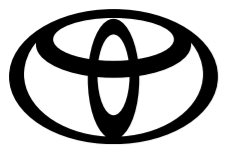

SPECIFICATIONS

EXTERIOR COLOURS

FOR ILLUSTRATIVE PURPOSES ONLY.

MONOTONE



ZHJ - Mystic Pearl White



WBE - Premium Liquid Silver



WBF - Shadow Grey



WAJ - Jet Blue



WBG - Luxe Red



ZAM - Shadow Black Pearl



ZQD - Smoke Black Pearl

BI-TONE

*XR MODELS



C9J - Mystic Pearl White Bi-Tone



ERD - Liquid Silver Bi-Tone



ESY - Jet Blue Bi-Tone



ESL - Luxe Red Bi-Tone

SPECIFICATIONS

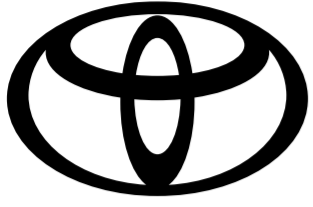

Disclaimer:

The information contained within or made available on any Toyota platform or note including but not limited to, this website/brochure/specification sheet, is provided for information purposes only. While we make reasonable efforts to update the information on our platform/s, Toyota Motor Corporation of Japan, and Toyota South Africa Motors (Pty) Ltd makes no representations, warranties, or guarantees, whether express or implied, that the content is accurate, complete or up to date, and all information contained herein is subject to change without notice.

Vehicle specifications may vary depending on the model, trim level, and market. Colours depicted on print and web material may not match the actual vehicle colour. Fuel consumption figures are estimates based on standardised testing conditions and actual results may vary due to (but not limited to) driving style, vehicle loading, tyres, wind, traffic, and accessories. All dimensions, capacities, and performance figures are approximate. Some features/options may be optional or only available on certain models/trim levels. Images and illustrations are for illustrative purposes only and may not reflect the actual vehicle.

Your use of, or reliance on, any information or contents herein is entirely at your own risk. Toyota Motor Corporation of Japan and Toyota South Africa Motors (Pty) Ltd (including its owners, agents, consultants, employees, and any affiliated person(s)) are not responsible for any loss or damages related to your use of, reliance on, or understanding of any information or contents on this or any other Toyota platform. This includes, without limitation, any direct, indirect, special, incidental, consequential, or punitive damages in terms of any contract, delict (breach of a duty of care) or law.

Furthermore, Toyota Motor Corporation of Japan and Toyota South Africa Motors (Pty) Ltd do not guarantee the uninterrupted or error-free operation of any platform or the availability of content, and are not liable for any interruptions, errors, or damages caused by any technical issues or limitations of these platforms, including but not limited to, server downtime, software malfunctions, or internet connectivity issues.

